

ring



Spotlight Cam Mount

# Smart Security at Every Corner of Your Home

Your new Spotlight Cam lets you extend the Ring of Security around your entire property.

Now, you'll always be the first to know when someone is in your yard, and you can watch over your home from anywhere.

Monitor your home, prevent crime, and protect your property – all from your phone, tablet or PC.

## Contents

1. Physical Installation
2. In-app Setup
3. Features
4. Troubleshooting
5. Advanced Installation Options



**WARNING:** Risk of electrical shock

Disconnect power at the fuse or circuit breaker before installing.

Verify that the supply voltage is correct. Connect fixture to a 100 VAC~240 VAC 50/60 Hz power source.

Always follow electrical code standards when installing wired connections.

If you are outside of North America, installation and wiring must be performed by a licensed electrician.

**CAUTION:** Risk of fire

Do not install near combustible or flammable surfaces

**NOTICE**

Do not connect this light fixture to a dimmer switch or timer.

Spotlight Cam Mount must be installed on a UL listed weatherproof electrical box.

# 1. Install your Spotlight Cam

# What's in the Box?

Everything you need to install your Spotlight Cam is included.

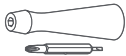

**Screwdriver & Phillips Bit**  
Use to install the box cover and tighten the security screw.



**Bag o' Screws & Washers**  
Use four screws when mounting to a round electrical box, or two when mounting to a rectangular box.



**Wire Nuts**  
Use to secure and protect wire connections.



**Hanging Hook**  
Use to hold the weatherproof box cover in position as you install.



**Round Weatherproof Box Cover**  
Use to mount your Spotlight Cam on a round weatherproof electrical box.

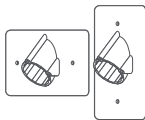

**Rectangular Weatherproof Box Covers (Vertical & Horizontal)**  
Use to mount your Spotlight Cam on a 1-gang rectangular weatherproof electrical box.

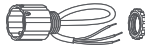

**Wiring Harness and Mounting Nut**  
Use to attach your Spotlight Cam to your chosen weatherproof box cover, and connect it to your household wiring.



**Oversized Weatherproof Gaskets (Optional)**  
Add to your chosen box cover to ensure good seal with oversized weatherproof boxes.



**Security Screw**  
Use to secure your Spotlight Cam to the box cover.

## How it All Fits Together

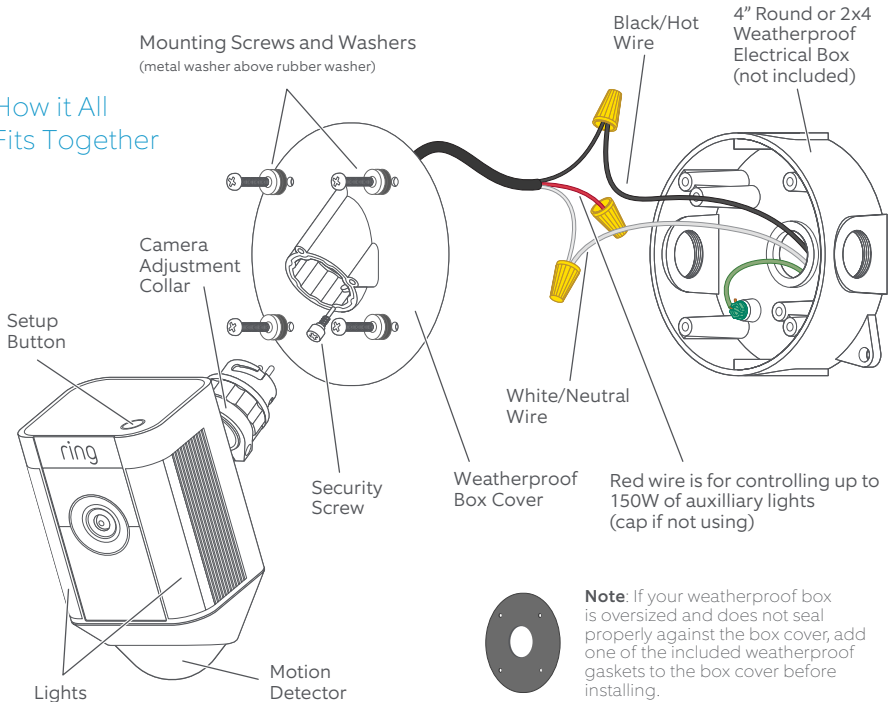

# Installation Height and Motion Detection

When mounted at the recommended height (9 feet up, with the motion sensor parallel to the ground), your Spotlight Cam is optimized to detect human-sized objects at up to 30 feet.

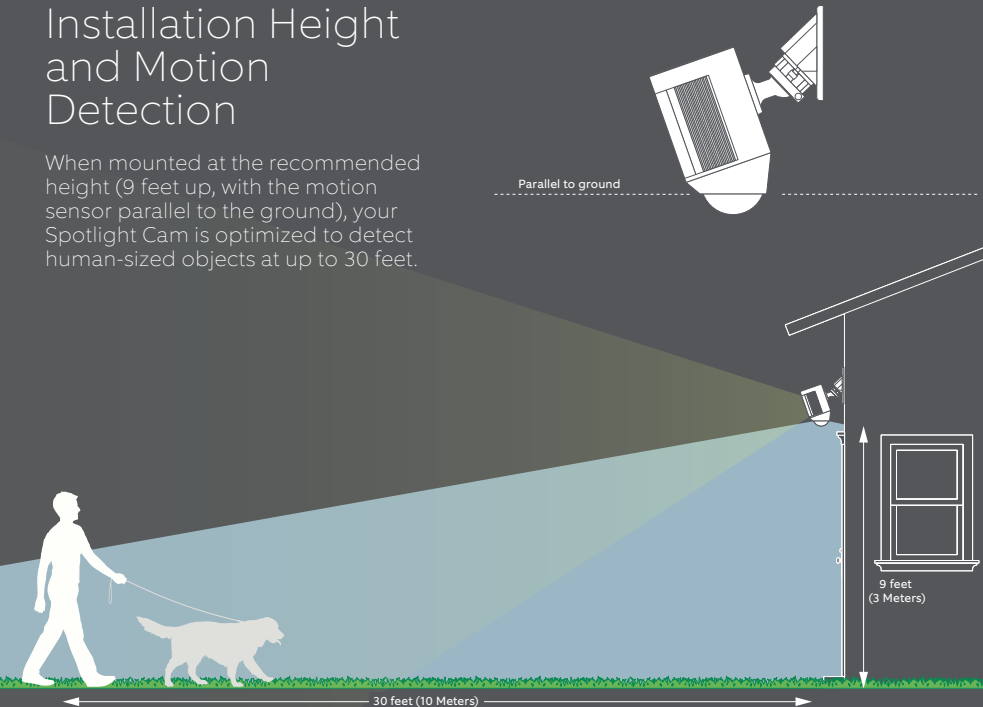

## Recommended Mounting Styles - Wall Mount

When mounting to a vertical wall, you'll usually want the mounting port to face downwards.

4" Round

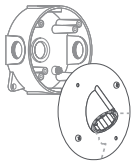

2x4 Vertical



2x4 Horizontal

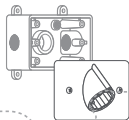

Ensure that the electrical box you use is weatherproof, including threaded plugs. Use sealant if necessary.

## Recommended Mounting Styles - Ceiling Mount

When mounting to a horizontal surface, face the mounting port in the direction you want the camera to see.

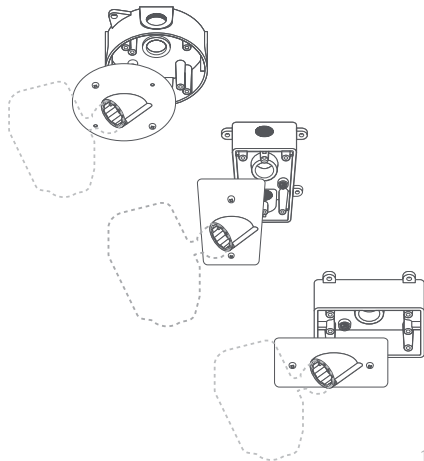

## Insert the Wiring Harness

Hold your chosen weatherproof box cover and your Spotlight Cam in the orientation you plan to install them.

Feed the wires through, then insert Spotlight Cam into the box cover.

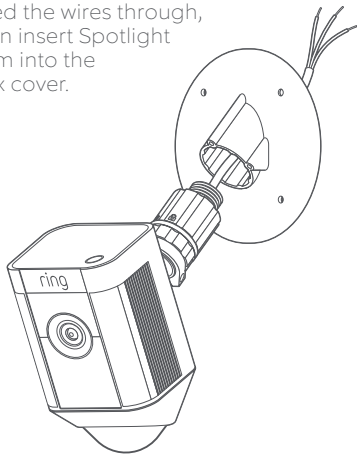

## Secure the Wiring Harness

Using the provided nut, secure the wiring harness to the box cover.

**Once the nut is tightened, turn your Spotlight Cam to the left to disengage it from the mount, and remove it, for now.**

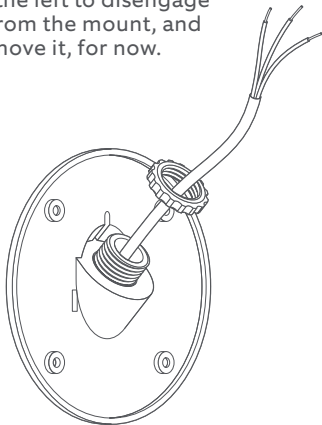



# Shut Power Off at the Breaker

If you don't know where your breaker is or how to turn off power to your electrical box, consult with a licensed electrician.

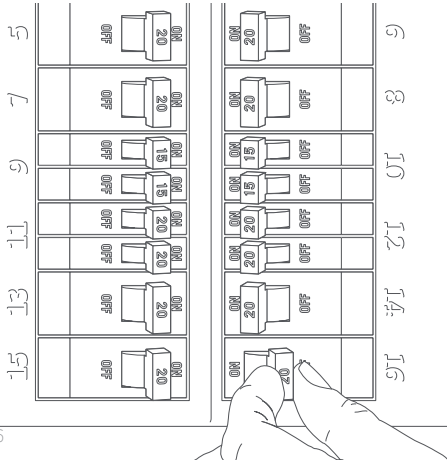

# Remove your Existing Light or Camera

**With power off at the breaker,** remove your existing floodlight or camera from the electrical box and disconnect the wires.

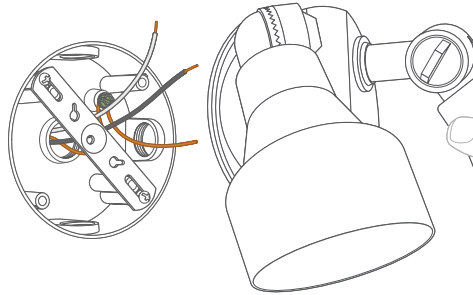

## Remove Existing Bracket (if present)

If there is a bracket attached to your electrical box, remove that as well.

Inspect the box to make sure water can't get in.

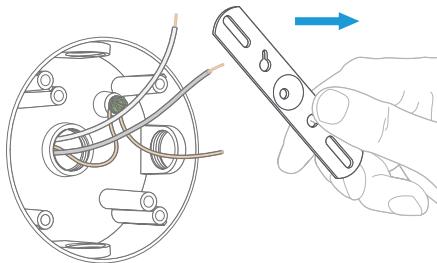

## Hang the Box Cover

Use the included hanging hook to hold the weatherproof box cover in place as you wire it in.

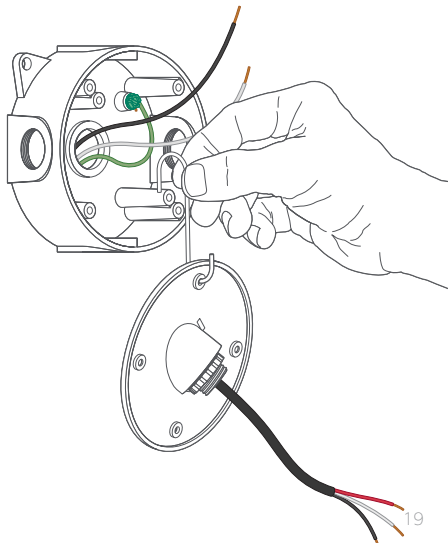

## Connect the Power Wires

Connect the black and white wires on the wiring harness to the black (hot) and white (neutral) wires coming out of your electrical box.

Use the included wire nuts to secure and protect the connections.

The red wire is optional, and should only be connected if you wish to control other lights with your Spotlight Cam.

For more installation info, see the **Advanced Installation Options** section.

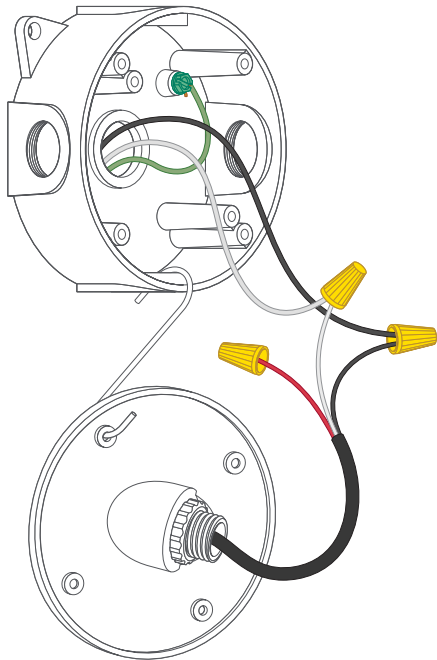

If you don't have clearly colored black and white wires coming out of your electrical box, consult with a licensed electrician.

## Screw in the Box Cover

Use the included screws to secure the box cover to the electrical box. Be sure to add a metal washer, then a rubber washer to each screw before inserting.



Some round boxes may only take two screws. Seal unused holes in the cover with the included screws and nuts. Add a metal washer backed by a rubber washer to each side before tightening the nut.

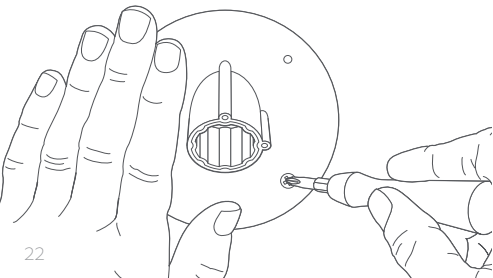

## Mount your Spotlight Cam

Insert your Spotlight Cam into the box cover. Once it's fully seated, turn to the right to lock it in.

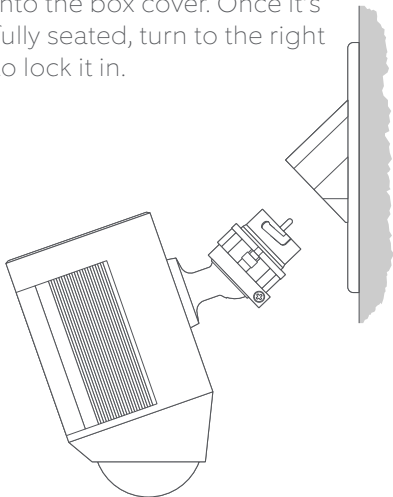

## Add the Security Screw

Insert and tighten the security screw to lock your Spotlight Cam into the box cover.

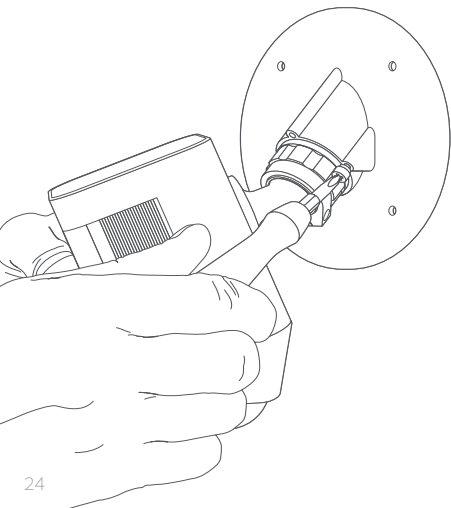

## Turn on Power at the Breaker

Once your Spotlight Cam is installed, it's time to turn power back on at the breaker. If the lights on your Spotlight Cam turn on, you're ready to go! If not, turn power off at the breaker and check your connections.

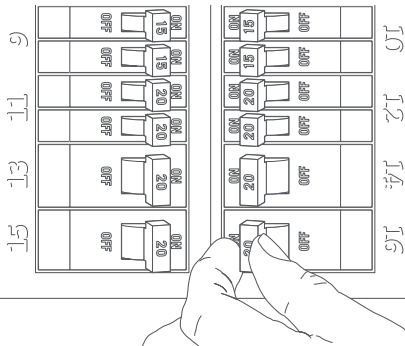

## 2. Set up your Spotlight Cam in the Ring app.

### Download the Ring app

The Ring app walks you through setting up and managing your Spotlight Cam.

Search for “Ring” in one of the app stores below, or visit: [ring.com/app](https://ring.com/app).



### Grab your Wi-Fi password

You'll need it for the in-app setup. Write it down below so it's handy when you need it:

Your Wi-Fi password 

# Connect your Spotlight Cam to the Ring App

In the Ring app, select **Set Up Device**.

When prompted, select **Spotlight Cam Mount** and follow the in-app instructions.



# Try it out!

After setup, tap the Live View button in the Ring app to see video from the camera.

If you have any problems, jump ahead to the Troubleshooting section.

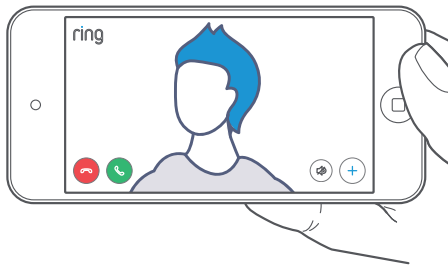

## White Light Flashing?

If the light on the bottom of your Spotlight Cam flashes or stays illuminated after setup, this means it's updating its internal software.

This update can take up to a few minutes. The light turns off when the update is complete.

## Adjust the Camera Angle

To ensure accurate motion detection, position your Spotlight Cam so the border of the motion detector is parallel with the ground.

Tighten the side screw to secure the camera position.

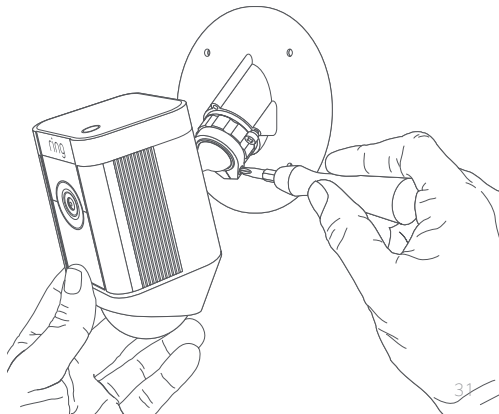



# 3. Check out all the Exciting Features.

## After Setup, Select your Spotlight Cam in the Ring App

This will bring you to the Device Dashboard, where you can change settings and access various features.

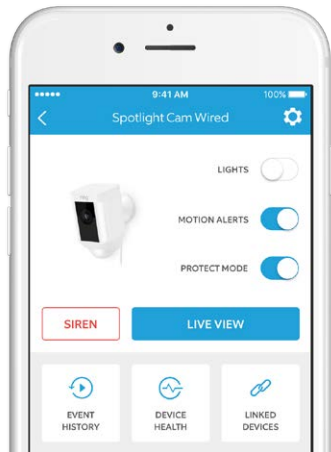

LIGHTS



Manually switch the lights on or off.

MOTION ALERTS



Turn notifications on or off for motion events.

SIREN

Trigger the siren to scare away intruders.

LIVE VIEW

Tap to see live video from Spotlight Cam. From here, you can see, speak and hear visitors, and control the siren and lights.



EVENT  
HISTORY

View a log of all the events captured by your Spotlight Cam in **Event History**.



DEVICE  
HEALTH

Visit **Device Health** to diagnose any problems you run into.



MOTION  
SETTINGS

Select **Motion Settings** to customize motion detection for motion alerts.



LIGHT  
SETTINGS

Adjust motion detection for the lights and set light brightness in **Light Settings**.

## Motion Detection



To receive motion alerts, you need to set up Motion Zones, which are customizable areas you want your Spotlight Cam to monitor.

To set up a Motion Zone, select Motion Settings. On this screen, create up to three Motion Zones. You need at least one active Motion Zone to get alerts.

## Notifications

If your phone is locked when the camera captures a live event, you receive a notification on your lock screen.

If your phone has a passcode, you'll need to enter it to access the live event.

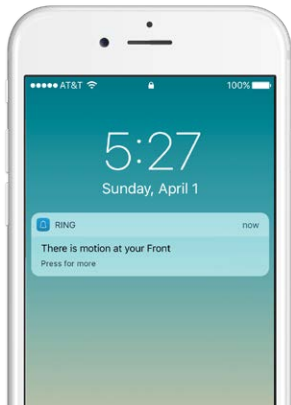





## Live Events



A live event begins when motion is detected or when selecting Live View.

During live events, you can access these features:

-  **Two-way Talk** – Speak to visitors and hear what they have to say.
-  **Siren** – Activate the siren.
-  **Lights** – Turn the lights on and off.
-  **Ring Neighborhoods** – Share suspicious events with neighbors.

## Ring Video Recording



This optional feature saves recordings of every event your Spotlight Cam captures, allowing you to share it with others.

You can access these events on any device running the Ring app or by logging into your account at: [ring.com/activity](https://ring.com/activity).

**Learn more at:**  
[ring.com/video-recording](https://ring.com/video-recording)

Your new Spotlight Cam includes a free trial of Ring Video Recording for you to enjoy. Watch your email inbox for important announcements about this service.

# 4. Advanced Installation Options

## Alternate Angles

The included weatherproof box covers are designed to mount your Spotlight Cam pointing downward from an elevated position.

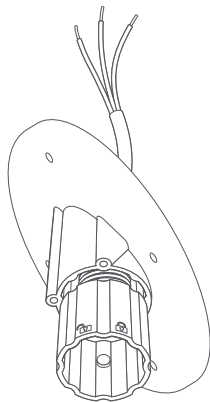

However, if you'd like to mount your Spotlight Cam at a different angle, just hold your chosen weatherproof box cover in the orientation you plan to install it, and follow the instructions on page 14.

# Auxiliary Light Control

Your Spotlight Cam has an advanced motion detection system. If you'd like other lights (such as floodlights) to be triggered by the motion detector in your Spotlight Cam, wire them according to this diagram.

Your connected lights also turn on when you manually enable your Spotlight Cam lights in the Ring app.



**Total power draw of connected lights must not exceed 150 watts.**

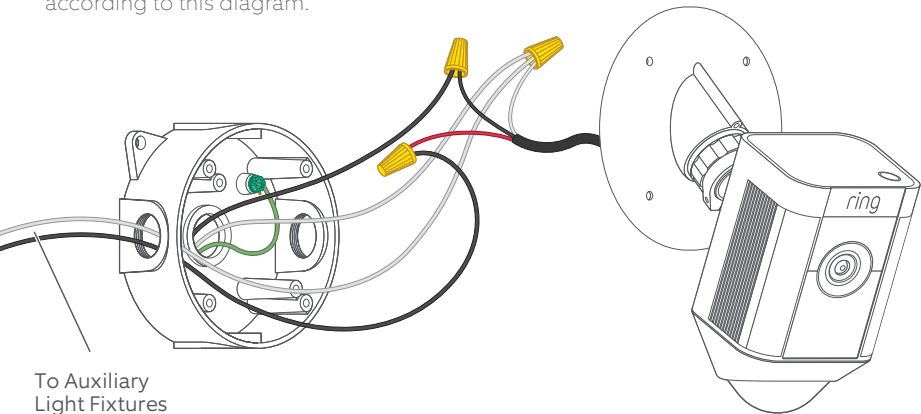

# Upgrade a Floodlight

If you have an existing motion detecting floodlight, you can replace its motion sensor with your Spotlight Cam for a massive upgrade!

To do so, disconnect the wires connected to the motion detector. Then, unscrew and remove the motion sensor from the floodlight and replace it with the included wiring harness.

With the floodlight in its normal install position, make sure that the lock-shaped symbols on the wiring harness face up (for wall mounting) or toward you (for eaves mounting).

Then, wire it in, following this diagram.



**Total power draw of connected lights must not exceed 150 watts.**



For LED floodlight, connect the red wire from your Spotlight Cam to the black wire on the LED driver circuit, then connect white to white.

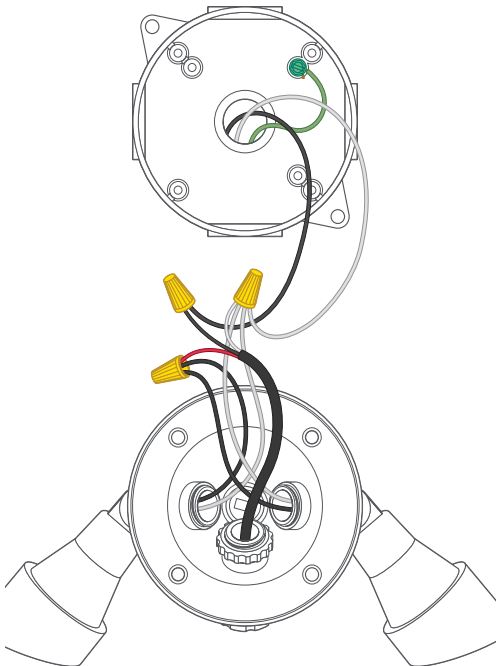

# 5. Having Trouble?

Here are  
Some  
Answers...

## **Spotlight Cam is not powering up.**

Check if there is a light switch controlling power to the electrical box where your Spotlight Cam is installed.

If so, make sure it stays switched on.

## **I'm having trouble completing the in-app setup**

If the in-app setup fails, look at the light on the bottom of your Spotlight Cam. What color is it?

**Flashing red** means your Wi-Fi password was entered incorrectly. Select your Wi-Fi network in your phone settings, select the option to forget it, then reconnect to confirm you're using the correct password in setup.



**Flashing blue** means your Spotlight Cam may be too far from your router to get a decent signal. You may need to get a **Ring Chime Pro** to boost the Wi-Fi signal to your Spotlight Cam.

Learn more at: [ring.com/chime-pro](https://ring.com/chime-pro)

**Flashing green** indicates a possible issue with your internet connection. Unplug your modem or router for 40 seconds, plug it back in and then repeat the setup process.

### **Why can't I find the temporary Ring network on my phone?**

If your phone fails to pick up the temporary Ring network, go to your phone settings, turn off your Wi-Fi connection, wait 30 seconds, and turn it back on. If the Ring network still fails to appear, check that your Spotlight Cam is connected to power.

### **If none of the above helped...**

Perform a hard reset on your Spotlight Cam by holding down the setup button for 15 seconds, waiting 30 seconds and repeating the setup process.

### **If that didn't help...**

Turn off cellular data and bluetooth on your mobile device and try setting up again.

### **If that didn't help...**

Try performing setup on a different mobile device.

## Why can't visitors hear me on my Ring when I talk through the app?

If you're on an iPhone or iPad, check the microphone permissions on your device. Select Settings, find Ring and select it. Make sure that the switch next to Microphone is toggled on.

If you're on an Android device, go to Settings > Application/Apps > Application Manager > Ring > Permissions. Ensure everything here is on.

## Spotlight Cam lights up, but I can't complete the in-app setup.

First, double-check your Wi-Fi password, since this is the most common cause of setup problems.

Second, check the distance to your Wi-Fi router or access point. Installing your Spotlight Cam too far from your access point may cause setup issues.

In this case, a **Ring Chime Pro** can help boost your WiFi signal and provide audible alerts from your Spotlight Cam and other Ring products.

Learn more at: [ring.com/chime-pro](https://ring.com/chime-pro)

## Why is my video or audio quality poor?

Issues with video or audio quality are usually related to Wi-Fi signal strength or Internet speed. For an optimal experience, we recommend Internet speeds of at least 2Mbps. Check your Internet speed by selecting Device Health in the Ring app, then selecting Test Your Wi-Fi.

If Internet speed is sufficient, stand near your Spotlight Cam and look at Signal Strength in Device Health. If Signal Strength is not Good, we recommend adding a **Ring Chime Pro** to boost the Wi-Fi signal to your Spotlight Cam.

For additional help, visit:  
[ring.com/help](https://ring.com/help)

Or give us a call...

**US 1 800 656 1918**

**Canada 1 855 300 7289**

**Mexico (D.F) 52 55 8526 5445**

**Worldwide +1 310 929 7085**

For a list of all our customer support numbers, visit:  
[ring.com/callus](https://ring.com/callus)